

Side view

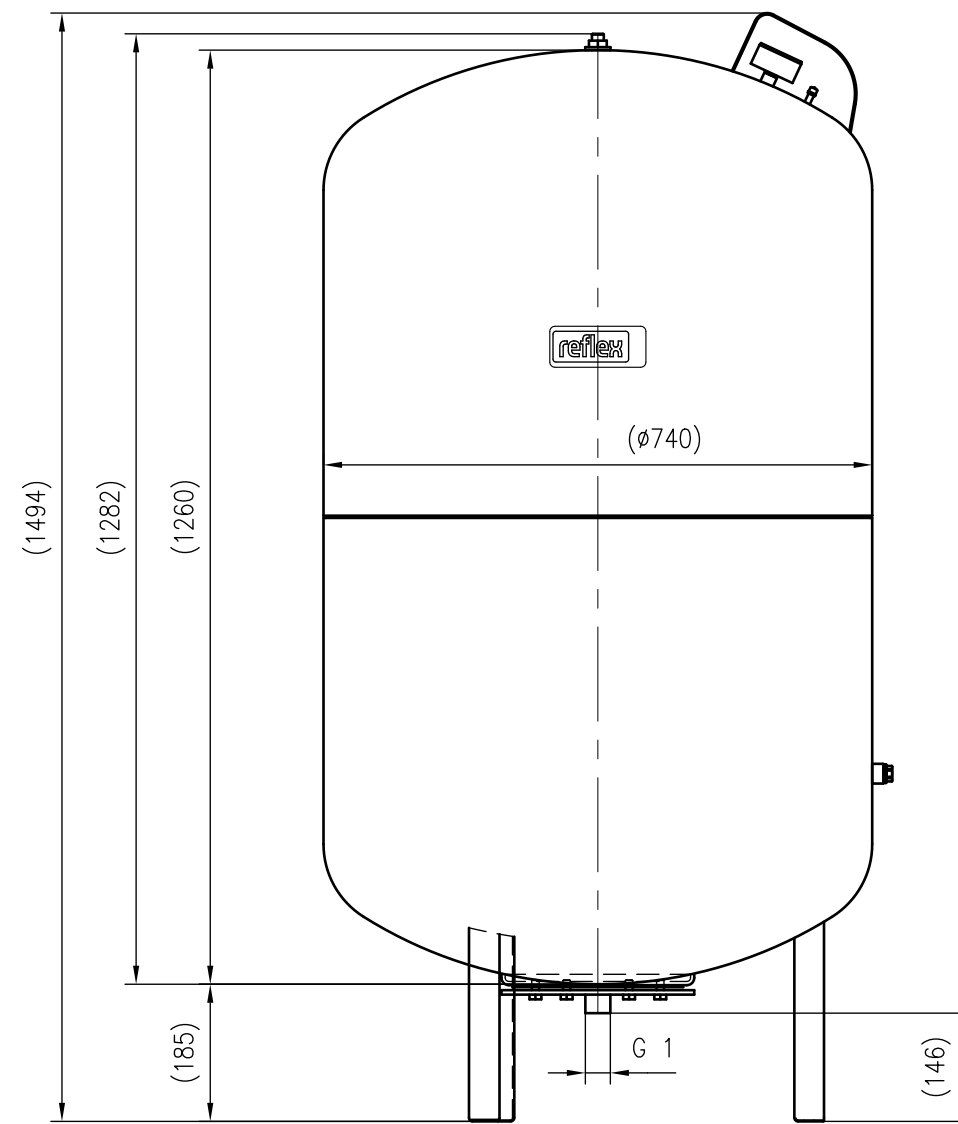

Front view

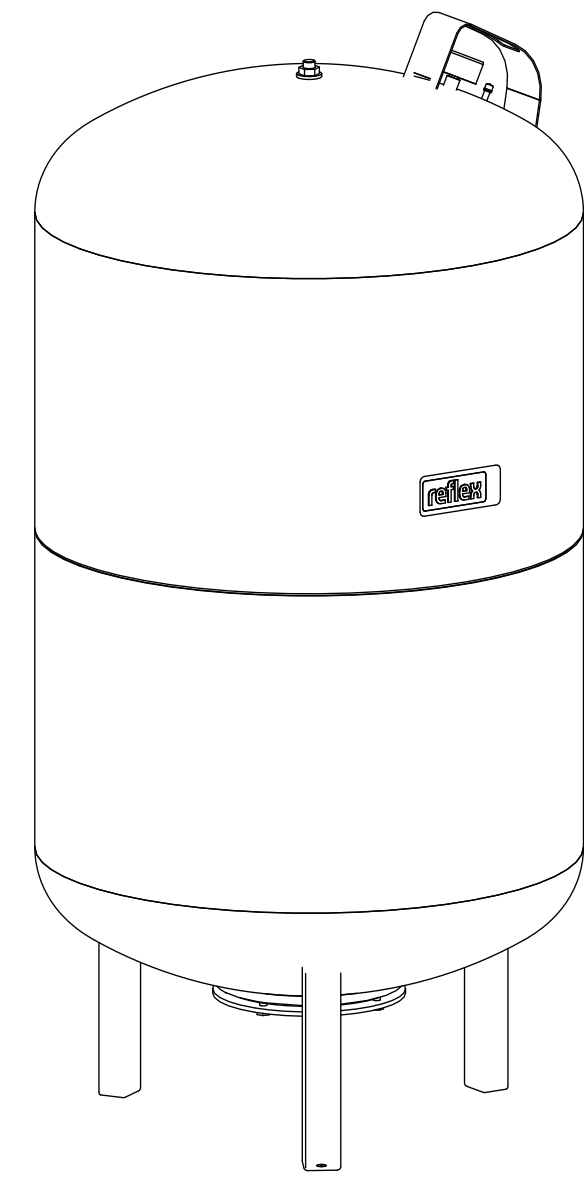

Isometric view

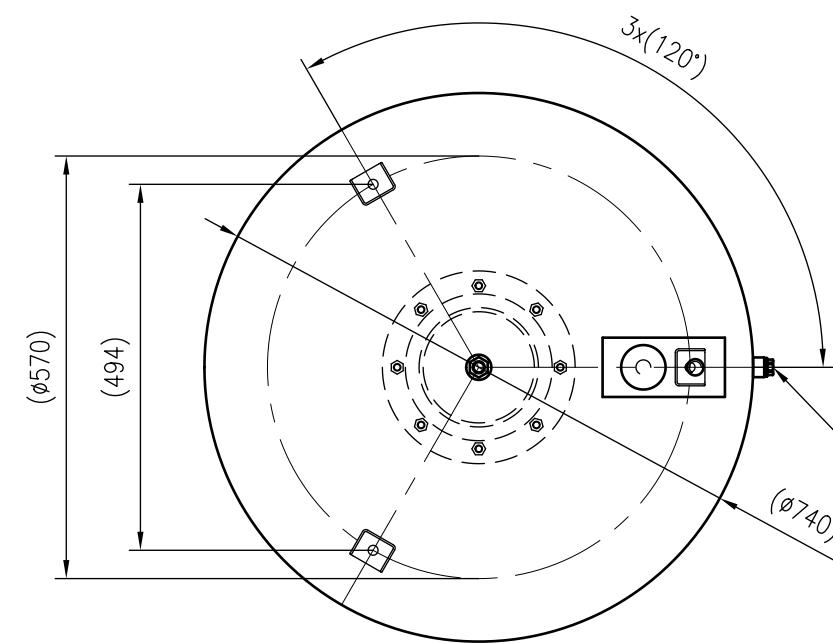

Top view

Optional auf Kundenwunsch mit
Membranbruchmelder REF-006357
Optional customizable with
bladder rupture detector REF-006357



Unterliegt nicht dem Änderungsdienst/ Not subject to change management		Maßstab/ Scale: 1:10	Format/ Size: A2
Revision 12.01.2017	Reflex G500 6bar – 8521705		